

Step into  
Luxury, Step  
into Life

Tessellae Tiles



# EVOKING LUXURY



# DELIVERING SPLENDOUR





# INTRODUCTION



**Concepts for  
Urban Spaces**

**We bring you  
magnificent range of  
superior surfaces with  
the magnificent  
Collection that  
Collection the style of  
a space with its  
poised and appealing  
designs.**

The colossal surfaces of the Collection are synonymous with luxury, radiance, and upscale living to design your spaces class-apart and truly matchless. These surfaces are specially designed to give your spaces the essence of grandeur and eliteness paired with unprecedented features, functionality, versatility, and elegance.

We believe in living life king size and with this belief, we offer grand-sized surfaces to create larger-than-life spaces that deliver a sense of surreality and luxury.

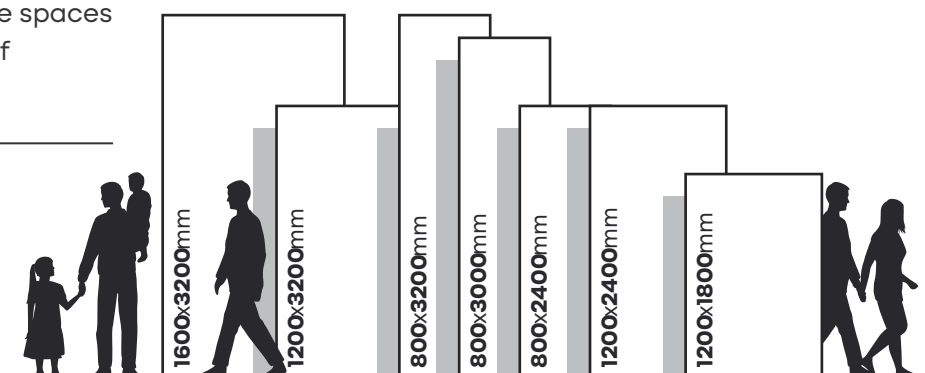



# THE SPECTACULARLY GLOSSY SURFACE



Discover the  
blend of  
technology  
and innovation

**The splendid Surface promises a sense of infinity and sophisticated feel for a place with its extravagant style. These tiles bring an effervescence vibe and charming poise to the interior.**

Spaces are blank pages that one can decorate in their personal style and write their lifestyle story. Every space lights up when the right elements come together and adding gloss to it just enhances the mood of the space. The tiles of amazing collection have a premium high gloss finish that expresses extravagance and delivers an elite experience. These surfaces enlighten spaces through their opulence and captivating semblance.



SURFACE  
HIGH GLOSS

# CONCEPTUALIZE YOUR SPACE IN A SUMPTUOUS STYLE

The spectacular collection is the epitome of grandeur and style. With this collection of brilliant Surfaces, luxury has a new size. They are designed to adorn places with a spacious look and chic style. The tiles of this collection are available in the grand size of 800x2400mm to create a lavish landscape.

## Types of Body

The Surface of the elegant Collection is an amalgamation of high gloss finish tiles available in four color bodies. These Surfaces shape spaces with utmost sophistication and chic style by embodying grace, poise, and grandeur.

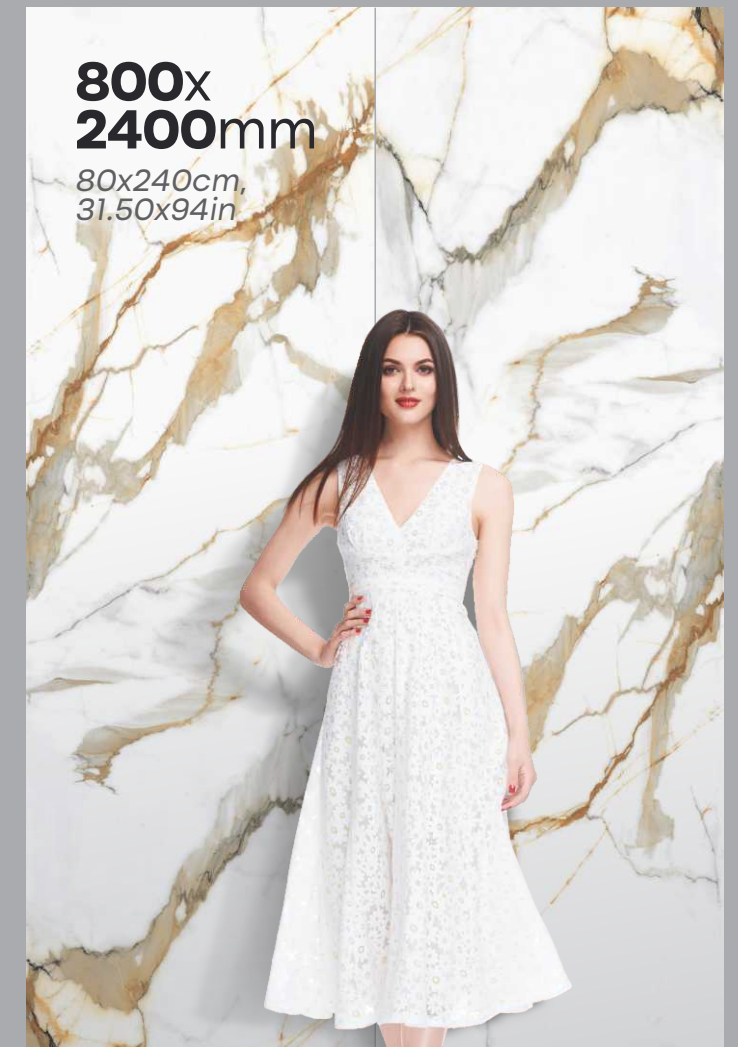

## BIG SIZE SLABS

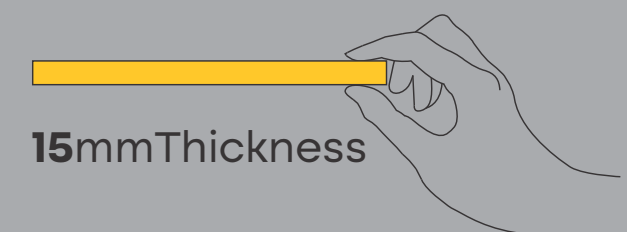

The 15mm thickness assures a sturdy and durable structure with its toughness. These surfaces enhance the spaces by fabricating modish tones for versatile areas.



# PERSONALIZE SPACES WITH VERSATILE APPLICATIONS

The brilliance and magnificence of the Surface enhance the aesthetic experience of a place.

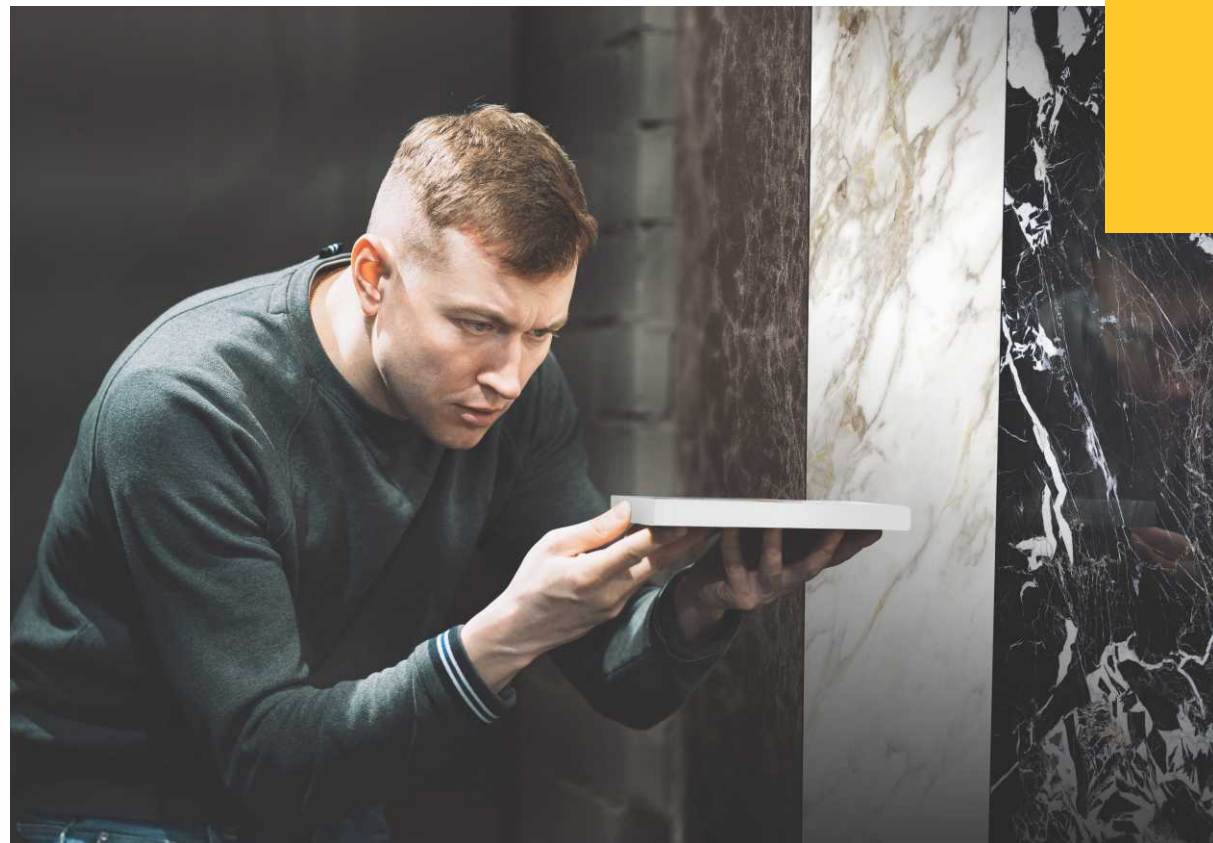













The aesthetical richness of our surfaces engulfs places in an oasis of surreal ambient with their mesmeric appeal. These majestic surfaces offer multiple installing options with their rich functionalities, sense

of comfort and pleasing designs. These tiles can be installed on countertops, furniture, floors, walls, staircase and many other areas of commercial as well as residential places.



## Application Areas

- |   |   |
|---|---|
|  Countertop      |  Staircase           |
|  Dining tabletop |  Window & Door Frame |
|  Lift Frame      |  Basin & Furniture   |
|  Bathroom        |  Fireplace           |
|  Worktop         |  Wall Cladding       |
|  Elevation       |  Floor Covering      |



# DESIGN SPACES WITH HIGH AESTHETIC IMPACT



DESIGN ELEMENTS  
THAT STAND OUT



The mesmerizing Surface adds character and poise to a place with its vivacious design and marvellous size.

The brilliant Surface is versatile in its surface. This collection creates the ideal ambience for various spaces like countertops, worktops, dining tables, staircases, and a lot more.

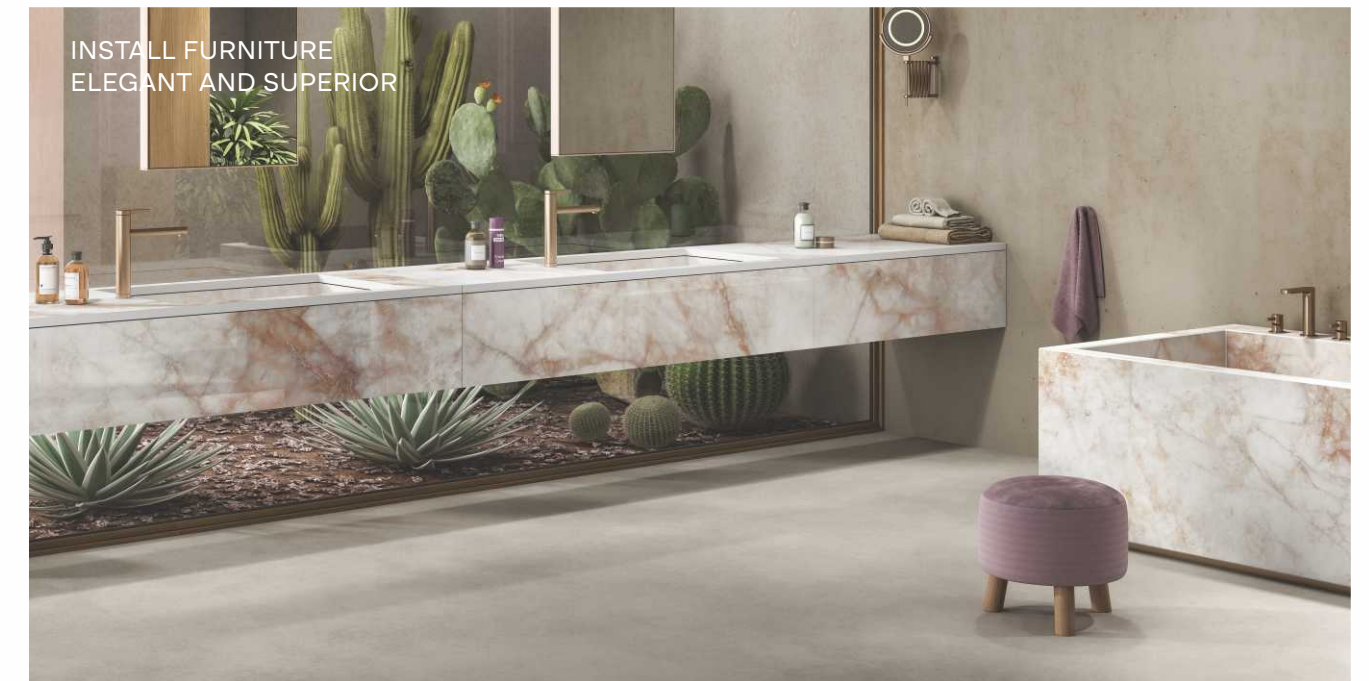

INSTALL FURNITURE  
ELEGANT AND SUPERIOR



# FOR SEAMLESS FUNCTIONALITY

In this time and age, hygiene, cleanliness and comfort is a priority and everyone requires a place where they feel completely at home. The multifaceted surfaces of this collection make everyday life easier while achieving distinction in the decor segment for every home and public area. These surfaces with their convenient features offer an ideal tiling solution for a modern lifestyle.

## TECHNICAL FEATURES



Hygienic and Suitable for Contact with Food



Water Resistant Surface



Stain Resistant Surface



Scratch and Abrasion Resistant



Resistant to Chemicals, Acids, Bases, and Solvents



Easy to Clean Surface



Impact Resistant Surface



Resistant to UV Rays



Resistant to Mould, Mildew, And Fungus



Resistant to Fire and Heat



Frost Resistant Surface



Flatness and Stability Over Time

# A GLORIOUS SELECTION

We offer a colourful palette of tiles with the Surface availing a spectrum of design options that help bring a designer's vision to life. These tiles make places desirable with their classy look and timeless shades that perfectly match the architectural style of urban spaces.

## WHITE BODY

FBV-80240-02-001



FBV-80240-02-002



FBV-80240-02-003



FBV-80240-02-004



FBV-80240-02-005



FBV-80240-02-006

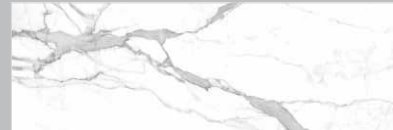

FBV-80240-02-007



FBV-80240-02-008



FBV-80240-02-009



FBV-80240-02-010



FBV-80240-02-011



FBV-80240-02-012

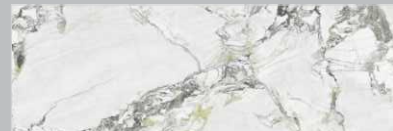

FBV-80240-02-013



## BLACK BODY

FBV-80240-02-014



FBV-80240-02-015



FBV-80240-02-016



FBV-80240-02-017

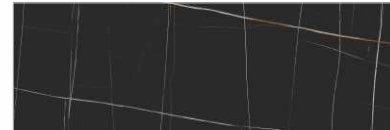

FBV-80240-02-018

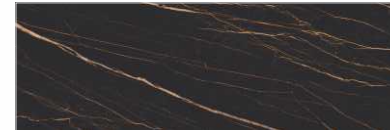

FBV-80240-02-019



FBV-80240-02-020

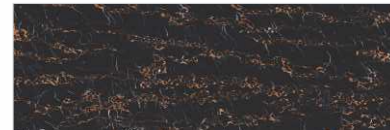

FBV-80240-02-021



FBV-80240-02-022



FBV-80240-02-023

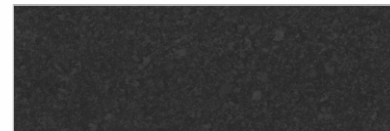

FBV-80240-02-024



## BROWN BODY

FBV-80240-02-025



FBV-80240-02-026



## BROWN BODY

FBV-80240-02-027

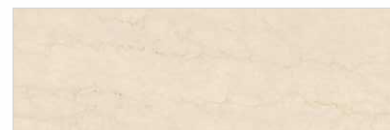

FBV-80240-02-028



FBV-80240-02-029





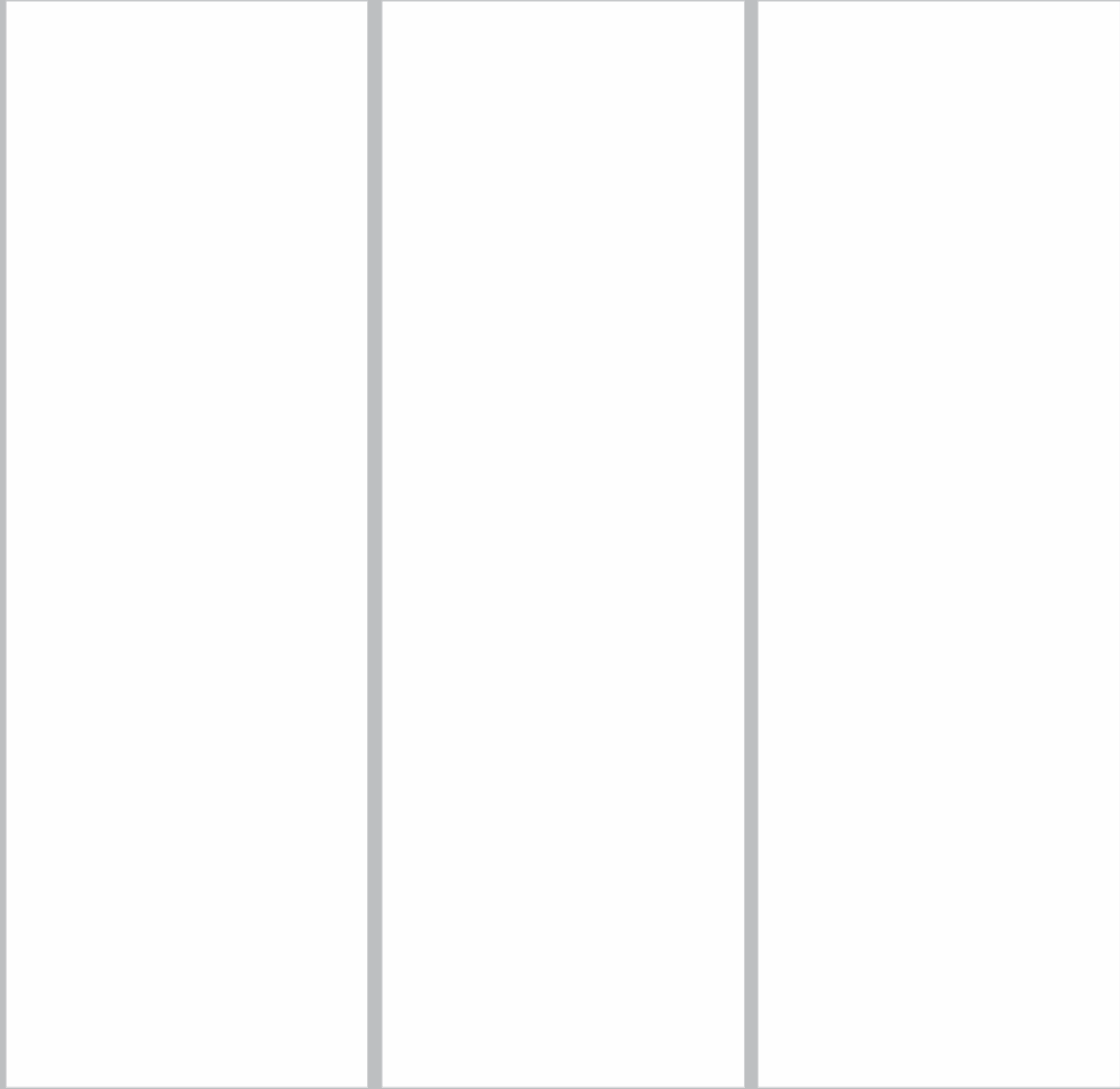

**FBV-80240-02-001**

Size **800x2400mm**  
Surface **High Gloss**  
Thickness **15mm**  
Type **White Body**



**FBV-80240-02-002**

Size **800x2400mm**  
Surface **High Gloss**  
Thickness **15mm**  
Type **White Body**





Kitchen Counter Top  
**FBV-80240-02-003**

Backsplash  
**FBV-80240-02-003**



**FBV-80240-02-003**

Size **800x2400mm**  
Surface **High Gloss**  
Thickness **15mm**  
Type **White Body**







Kitchen Counter Top  
FBV-80240-02-005





**FBV-80240-02-004**

Size **800x2400mm**  
Surface **High Gloss**  
Thickness **15mm**  
Type **White Body**



**FBV-80240-02-005**

Size **800x2400mm**  
Surface **High Gloss**  
Thickness **15mm**  
Type **White Body**





Wall  
FBV-80240-02-006

Sink  
FBV-80240-02-017





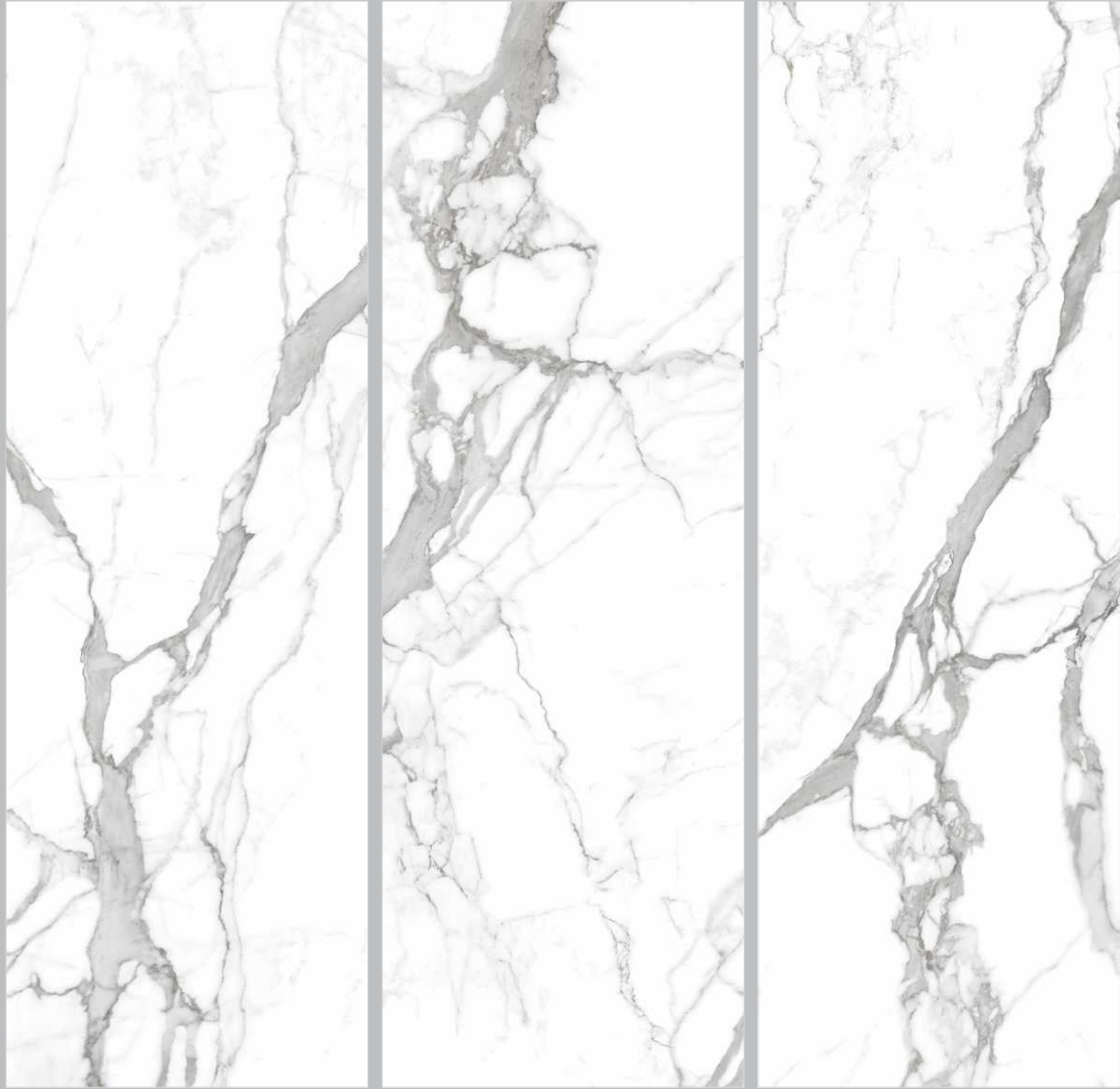

**FBV-80240-02-006**

Size **800x2400mm**  
Surface **High Gloss**  
Thickness **15mm**  
Type **White Body**



**FBV-80240-02-007**

Size **800x2400mm**  
Surface **High Gloss**  
Thickness **15mm**  
Type **White Body**





**FBV-80240-02-008**

Size **800x2400mm**  
Surface **High Gloss**  
Thickness **15mm**  
Type **White Body**



**FBV-80240-02-009**

Size **800x2400mm**  
Surface **High Gloss**  
Thickness **15mm**  
Type **White Body**







Basin  
**FBV-80240-02-011**

Bathtub  
**FBV-80240-02-011**





**FBV-80240-02-010**

Size **800x2400mm**  
Surface **High Gloss**  
Thickness **15mm**  
Type **White Body**



**FBV-80240-02-011**

Size **800x2400mm**  
Surface **High Gloss**  
Thickness **15mm**  
Type **White Body**







**FBV-80240-02-012**

Size **800x2400mm**  
Surface **High Gloss**  
Thickness **15mm**  
Type **White Body**

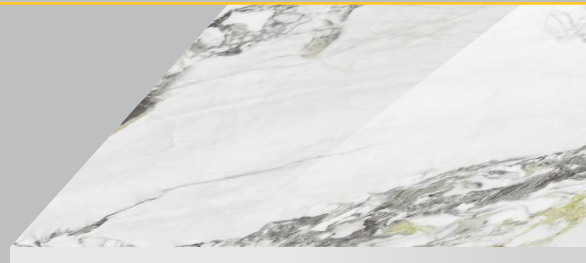

**FBV-80240-02-013**

Size **800x2400mm**  
Surface **High Gloss**  
Thickness **15mm**  
Type **White Body**

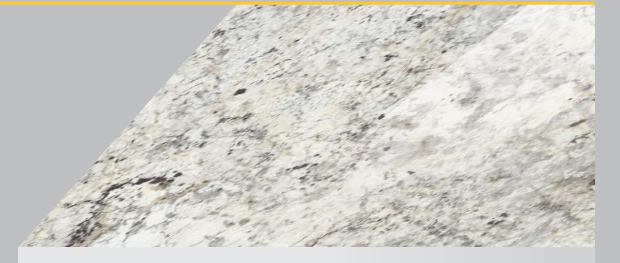

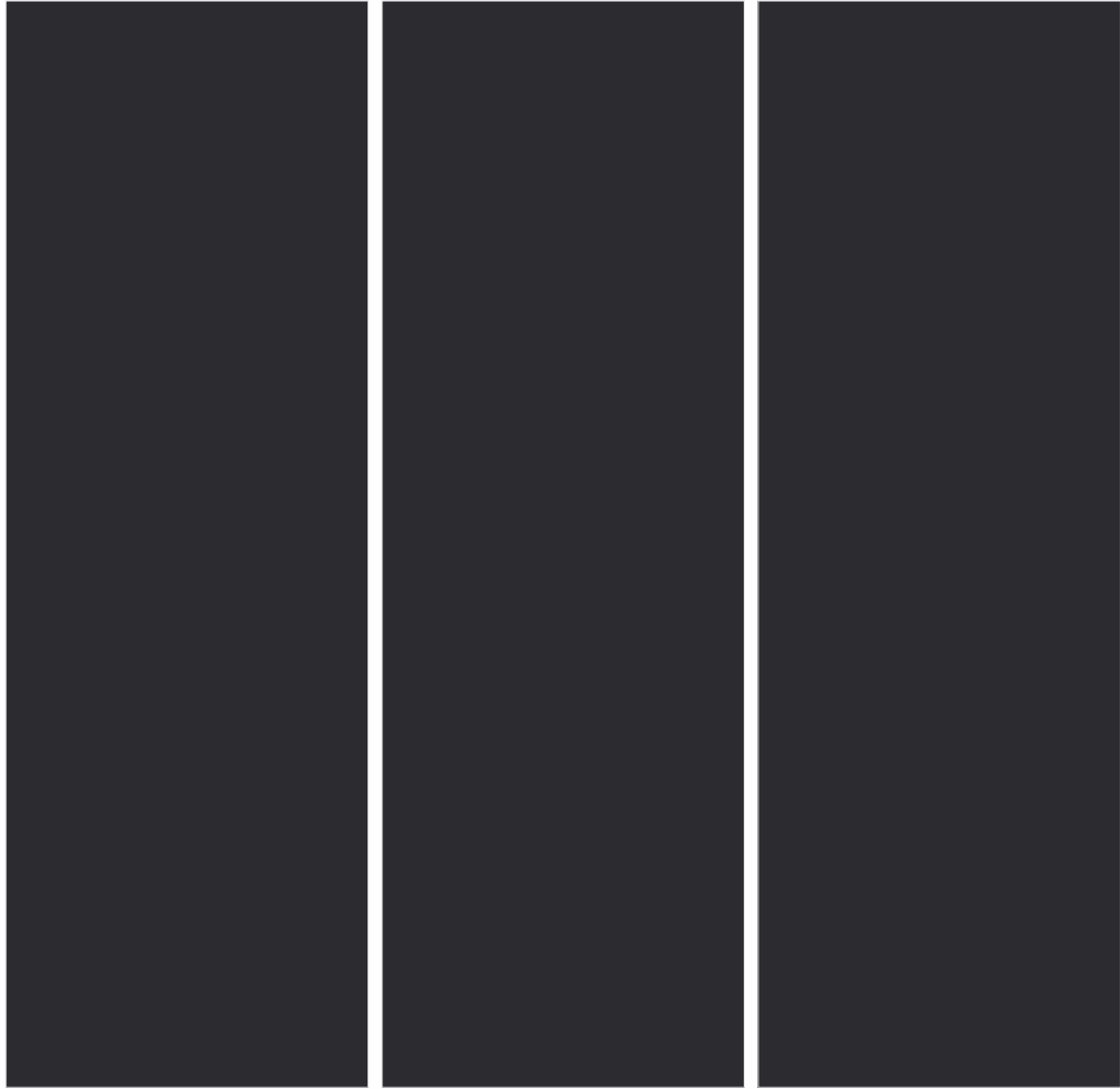

**FBV-80240-02-014**

Size **800x2400mm**  
Surface **High Gloss**  
Thickness **15mm**  
Type **Black Body**

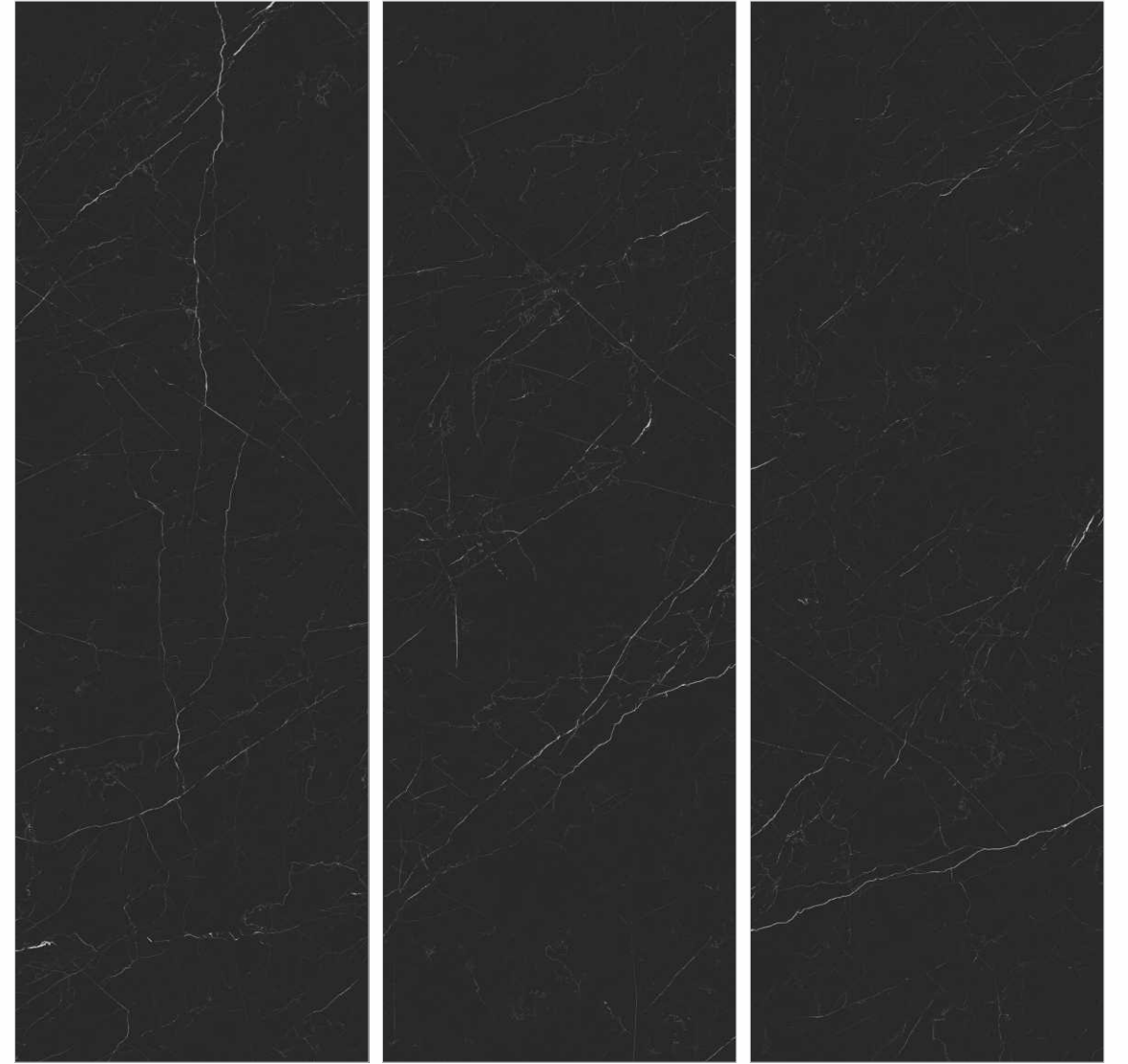

**FBV-80240-02-015**

Size **800x2400mm**  
Surface **High Gloss**  
Thickness **15mm**  
Type **Black Body**







Door And Window Frame  
**FBV-80240-02-017**

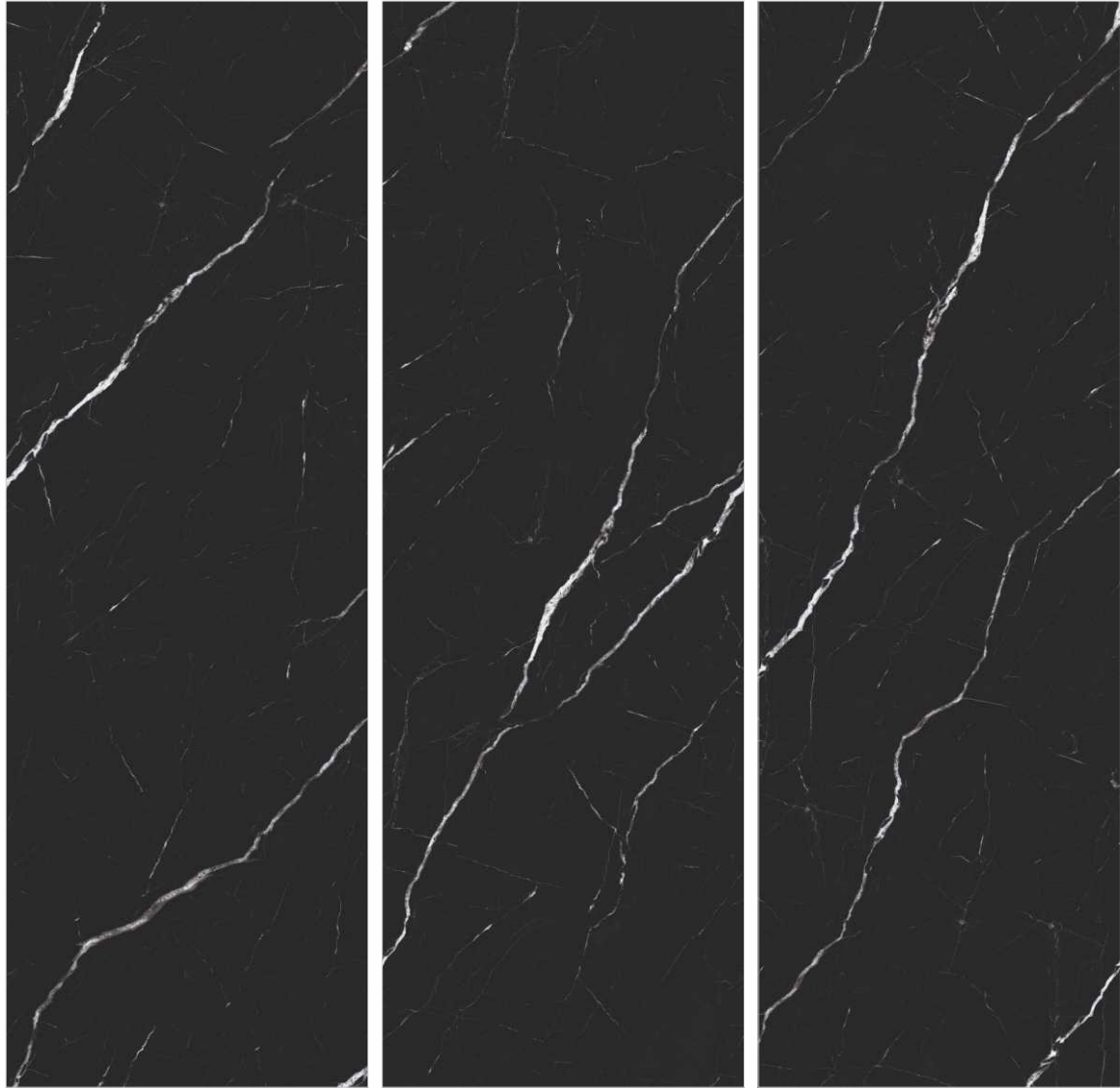

**FBV-80240-02-016**

Size **800x2400mm**  
Surface **High Gloss**  
Thickness **15mm**  
Type **Black Body**

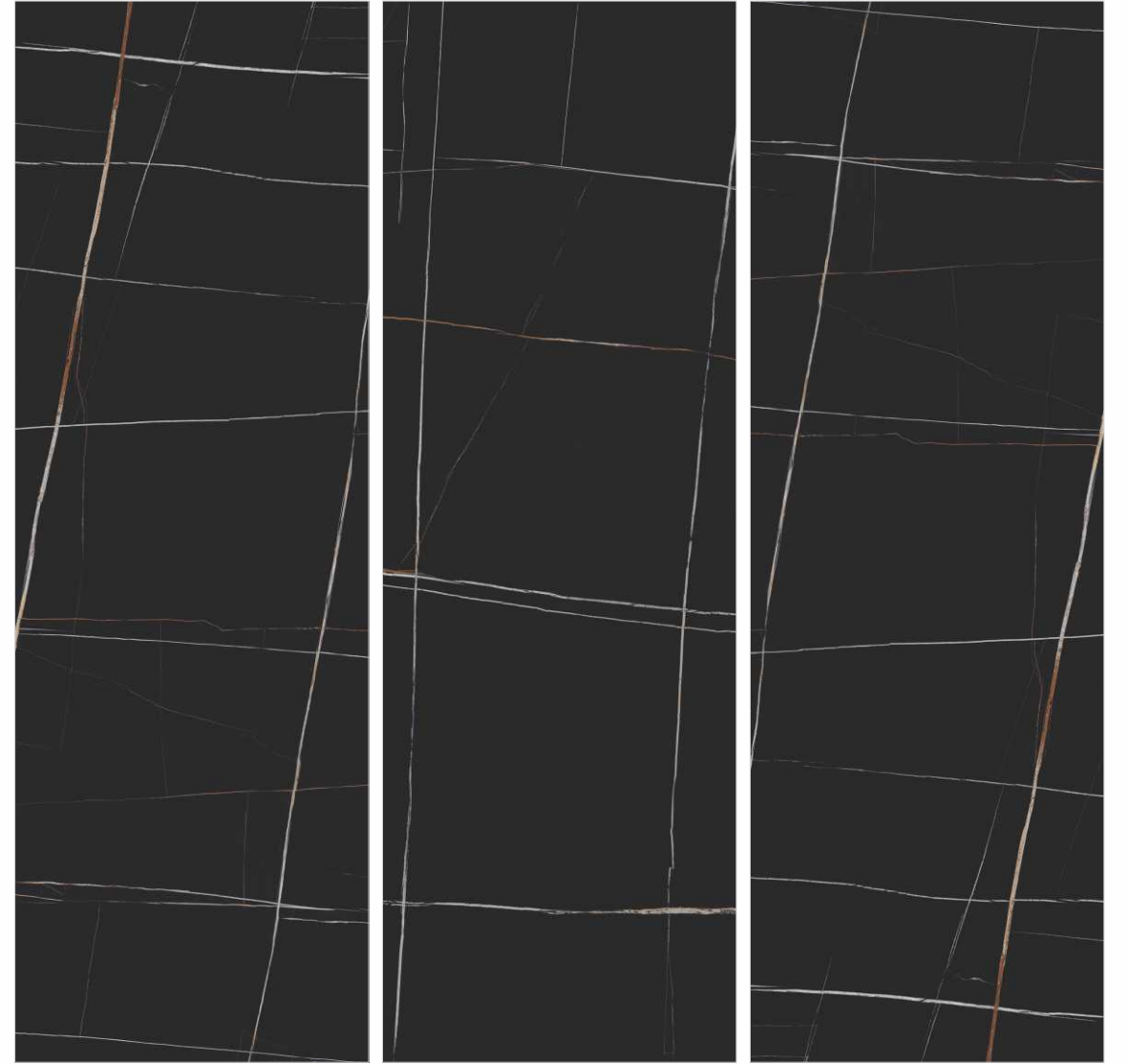

**FBV-80240-02-017**

Size **800x2400mm**  
Surface **High Gloss**  
Thickness **15mm**  
Type **Black Body**







Staircase  
**FBV-80240-02-018**

Floor  
**FBV-80240-02-009**

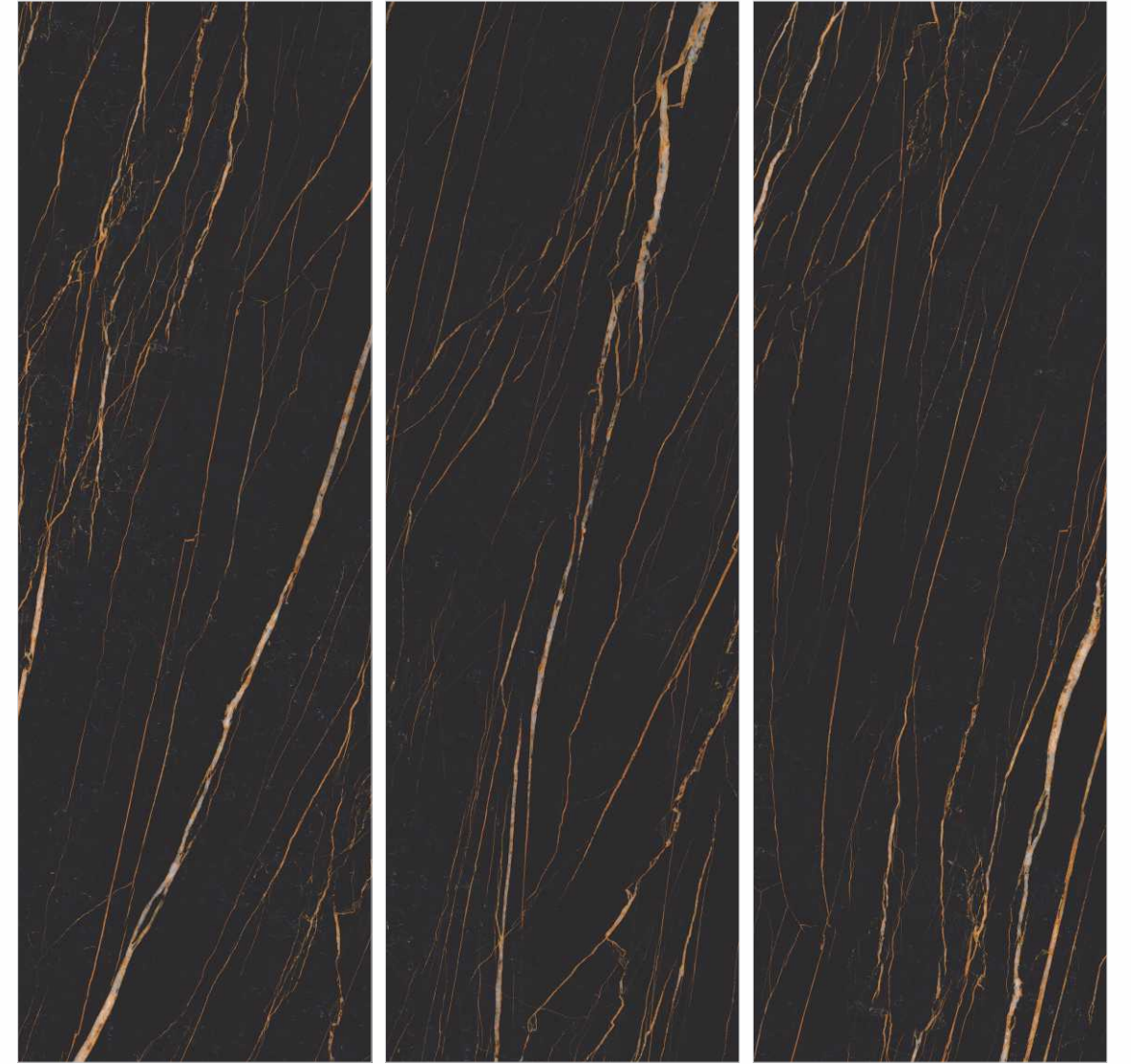
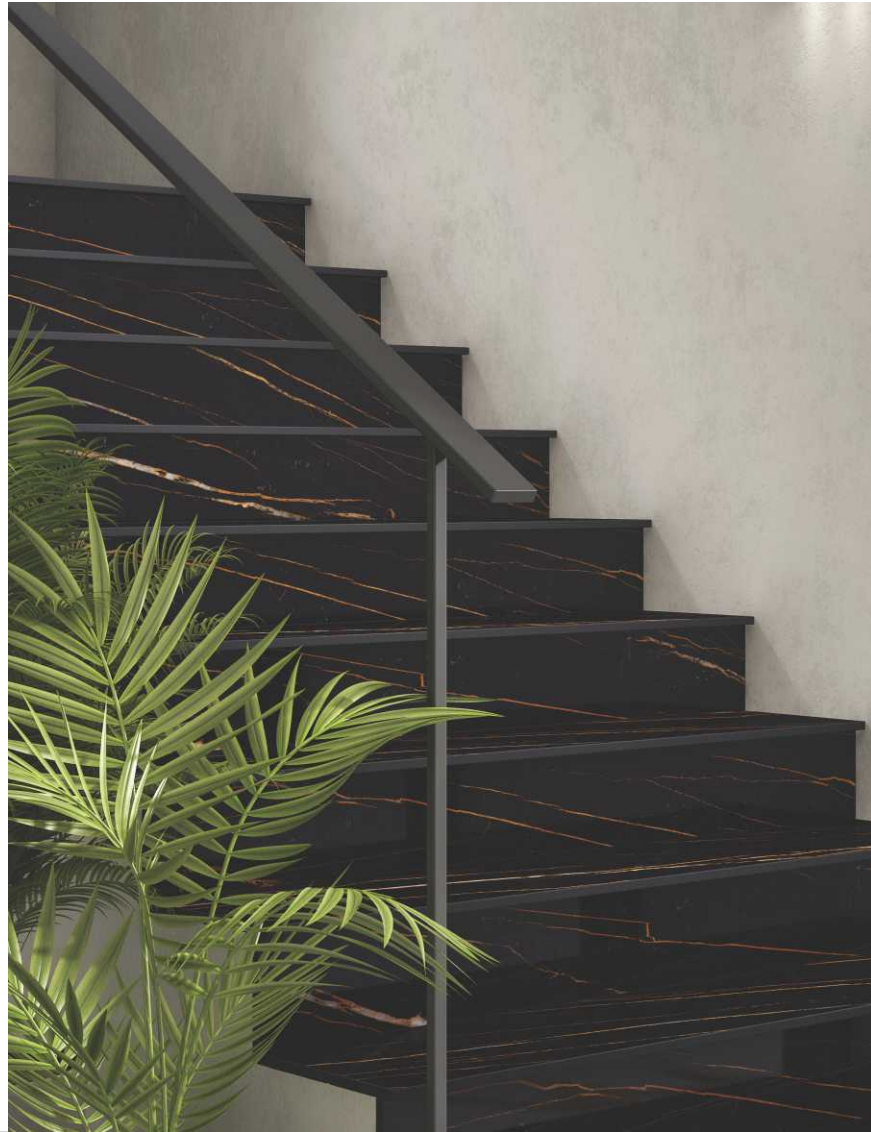

**FBV-80240-02-018**

Size **800x2400mm**  
Surface **High Gloss**  
Thickness **15mm**  
Type **Black Body**





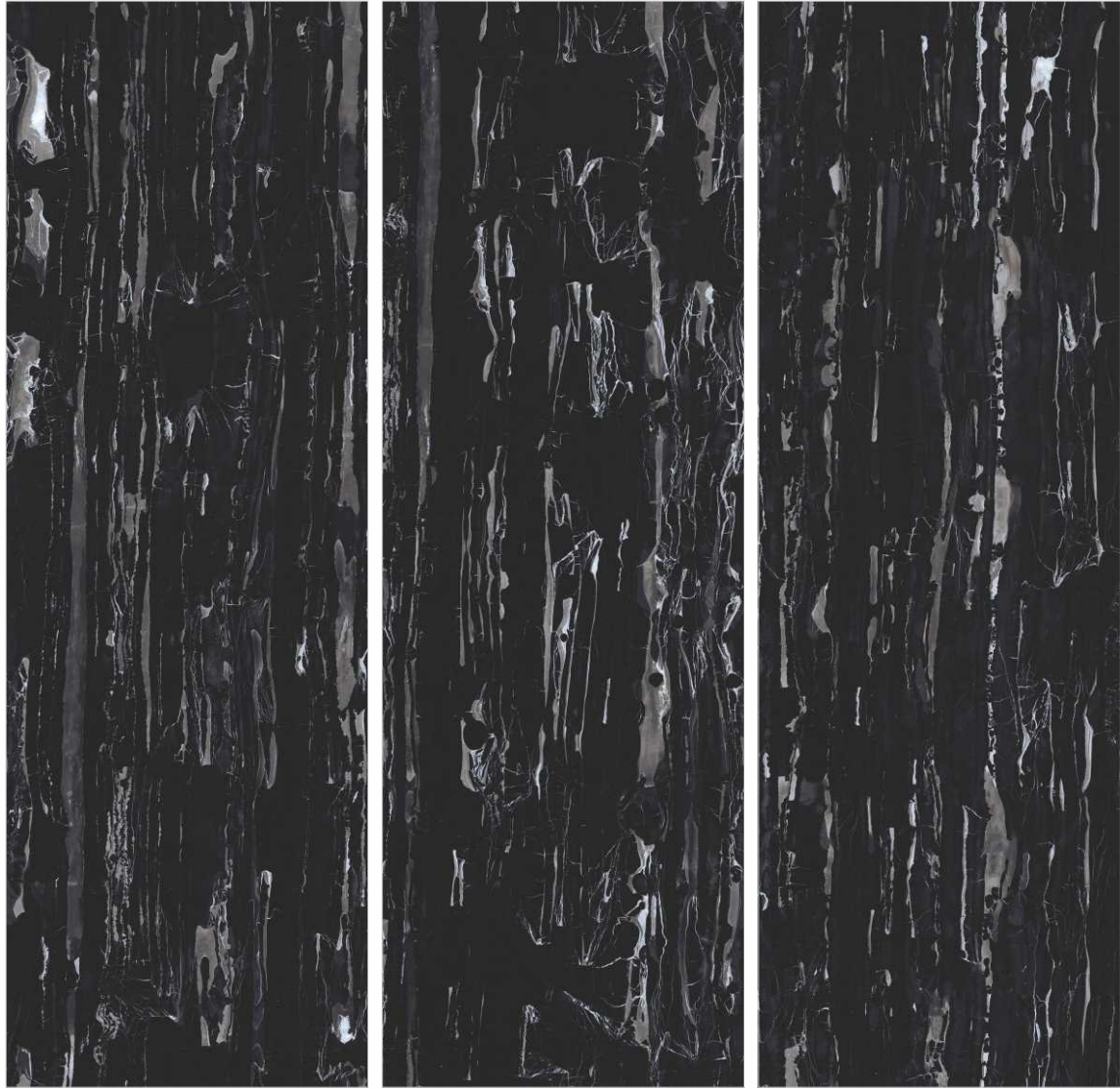

**FBV-80240-02-019**

Size **800x2400mm**  
Surface **High Gloss**  
Thickness **15mm**  
Type **Black Body**

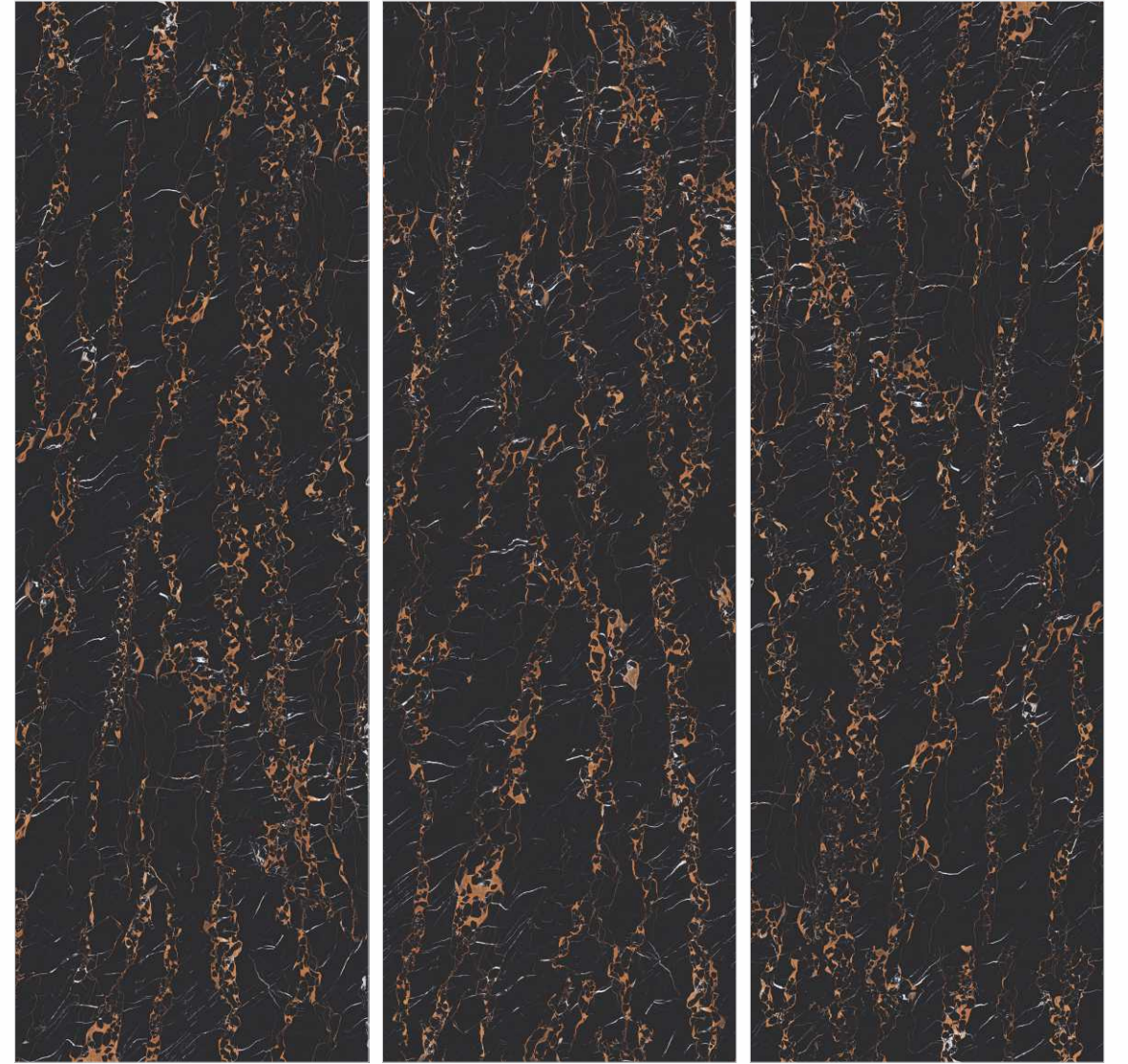
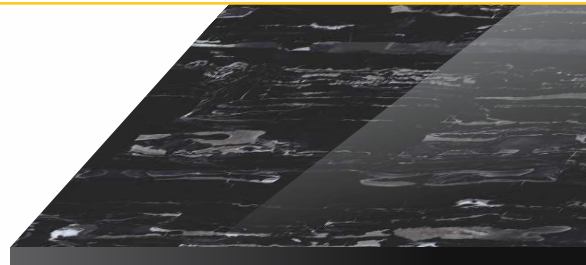

**FBV-80240-02-020**

Size **800x2400mm**  
Surface **High Gloss**  
Thickness **15mm**  
Type **Black Body**

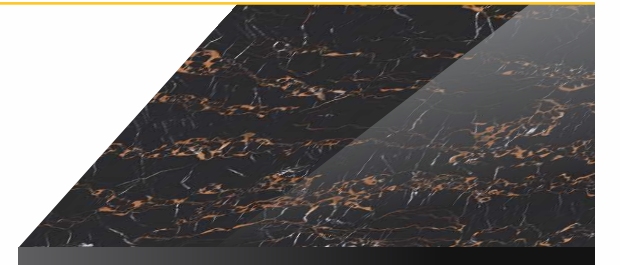



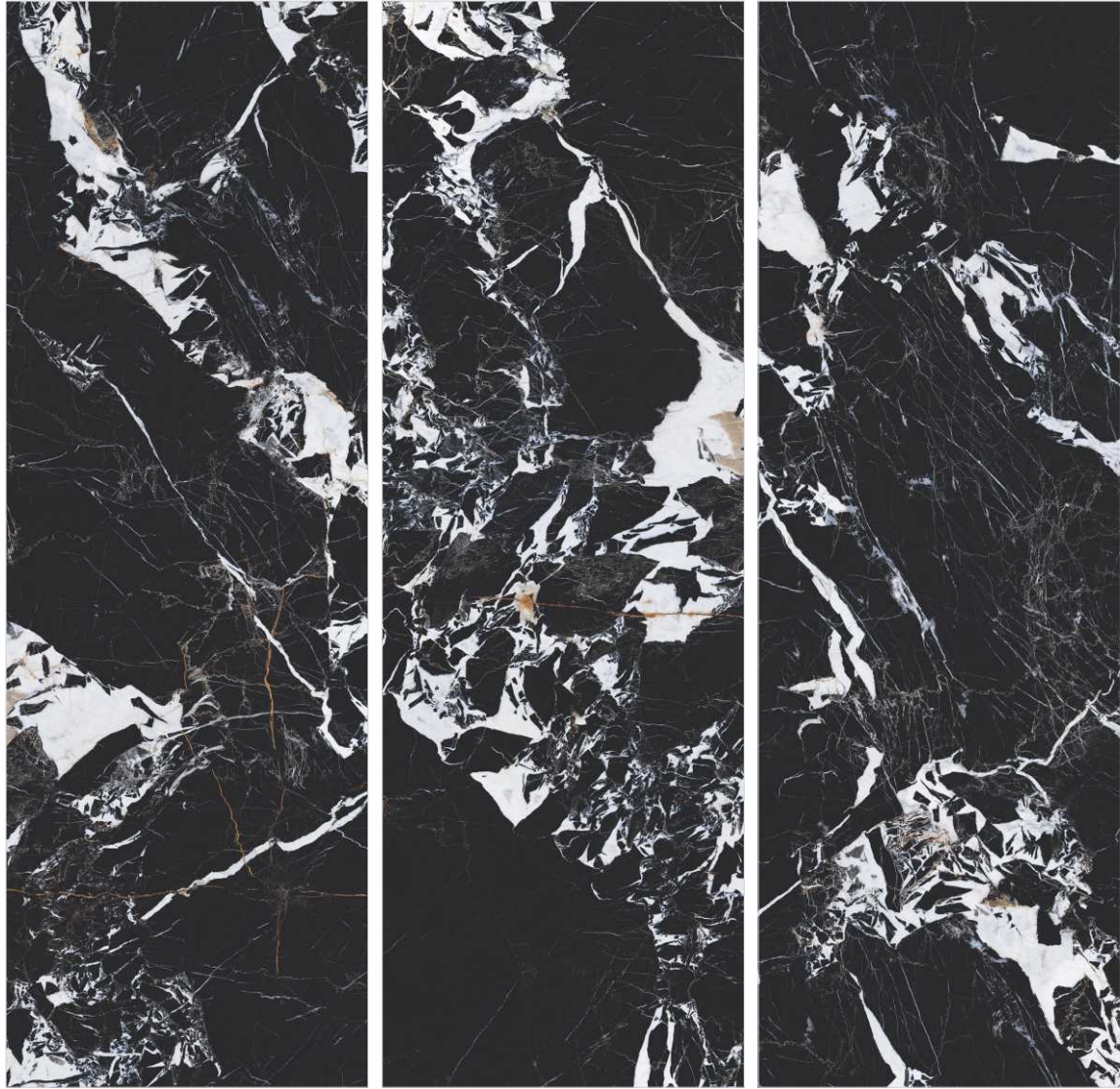

**FBV-80240-02-021**

Size **800x2400mm**  
Surface **High Gloss**  
Thickness **15mm**  
Type **Black Body**

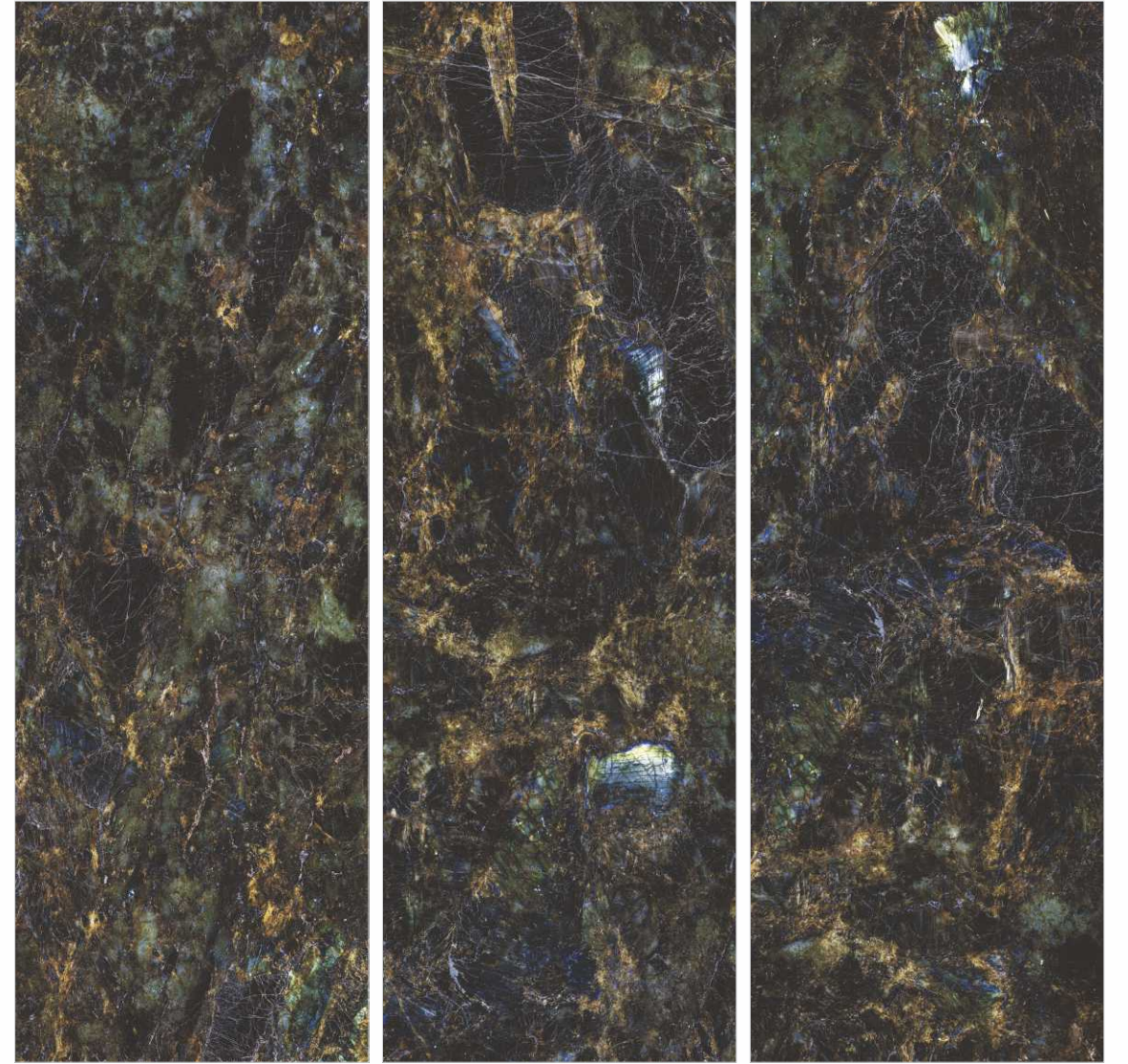
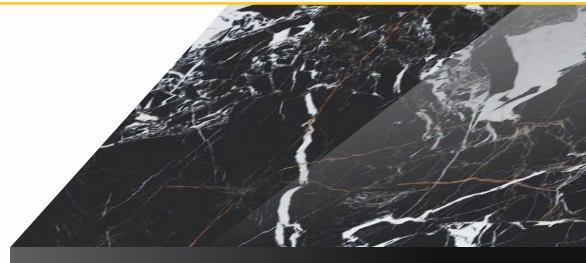

**FBV-80240-02-022**

Size **800x2400mm**  
Surface **High Gloss**  
Thickness **15mm**  
Type **Black Body**





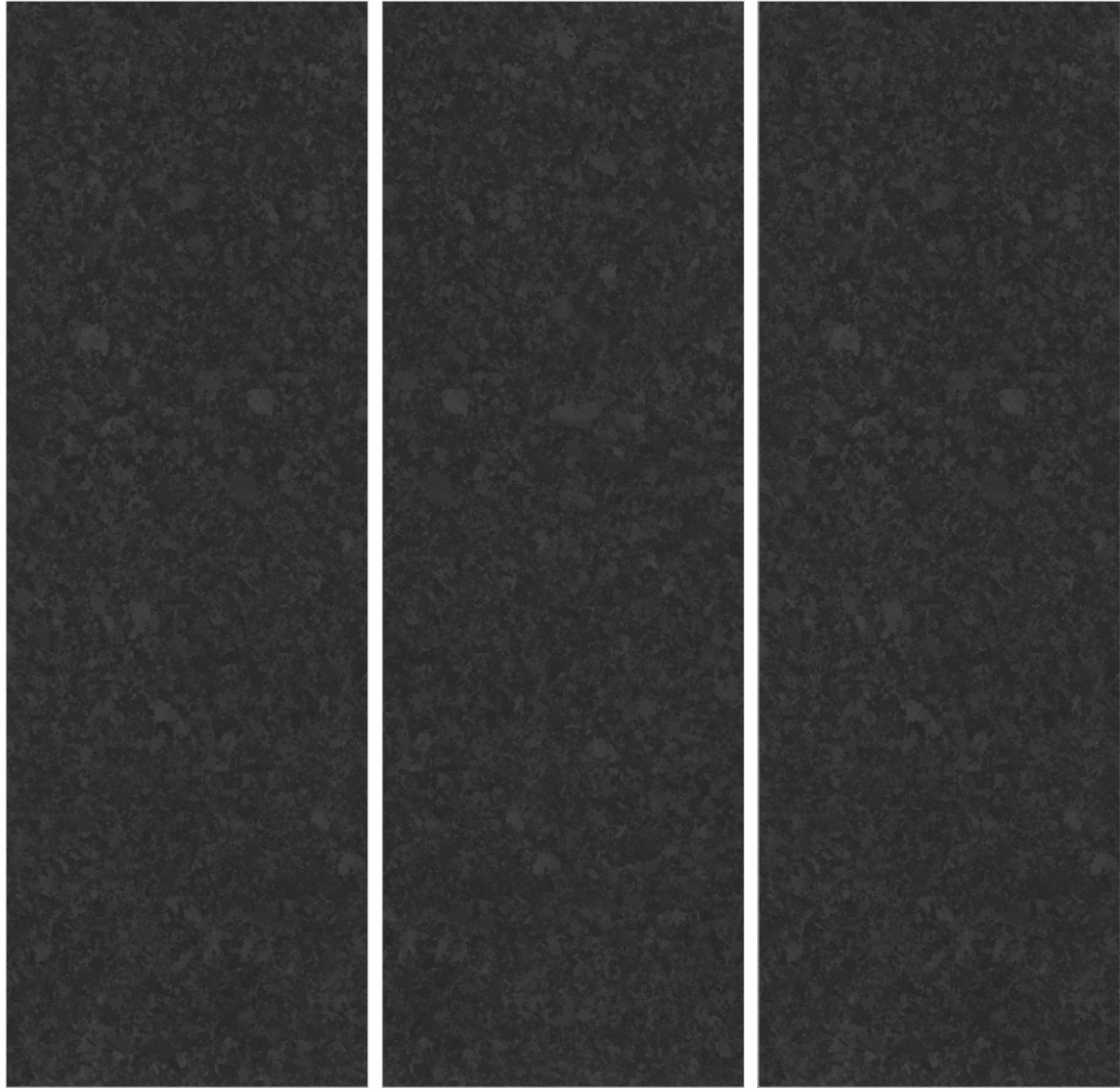

**FBV-80240-02-023**

Size **800x2400mm**  
Surface **High Gloss**  
Thickness **15mm**  
Type **Black Body**

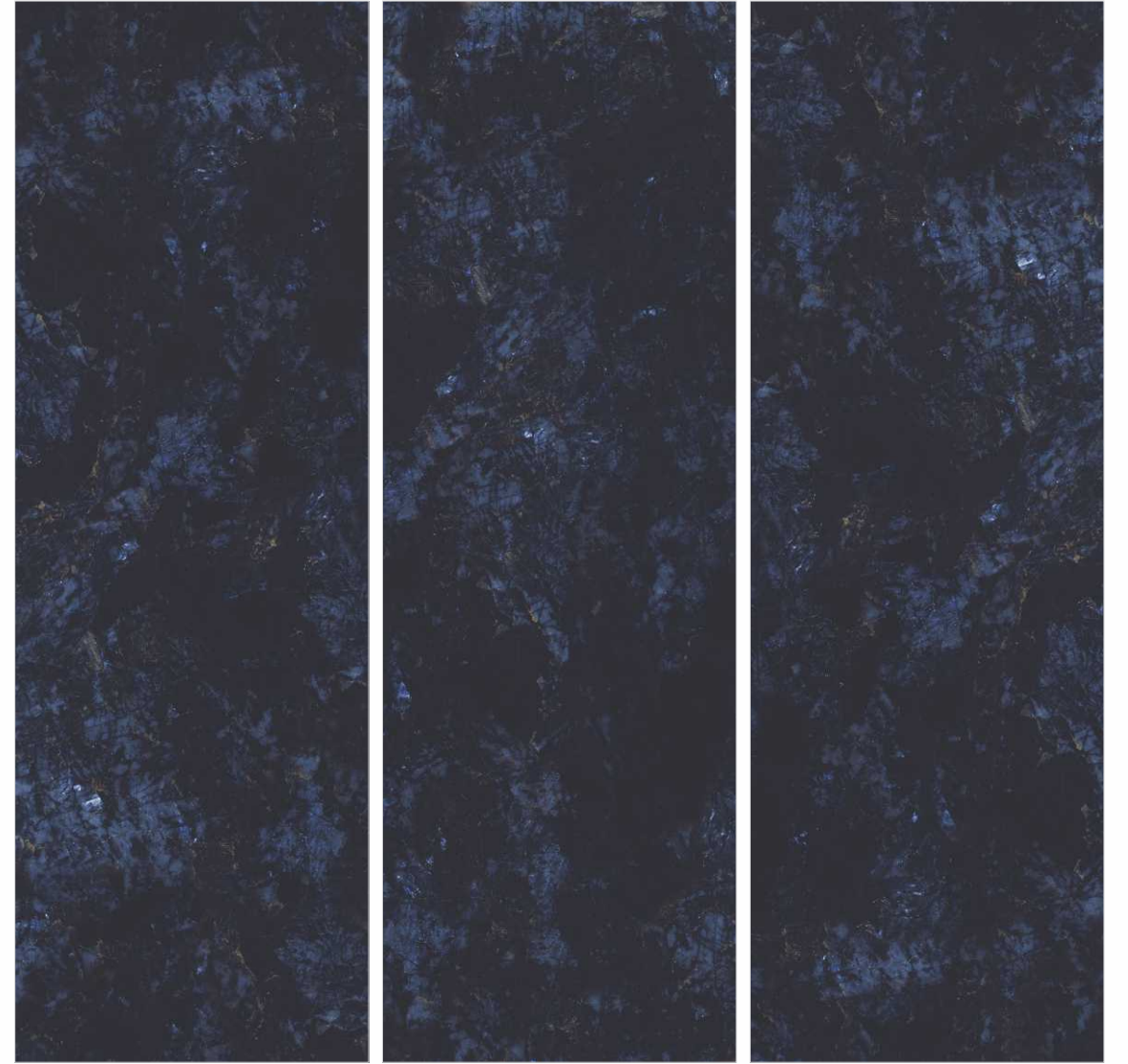
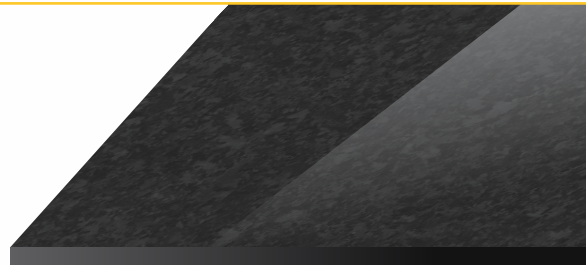

**FBV-80240-02-024**

Size **800x2400mm**  
Surface **High Gloss**  
Thickness **15mm**  
Type **Black Body**

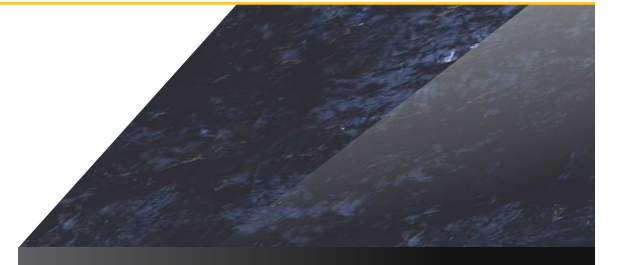





Table Top **FBV-80240-02-025**



**FBV-80240-02-025**

Size **800x2400mm**  
Surface **High Gloss**  
Thickness **15mm**  
Type **Grey Body**







Kitchen Counter Top  
**FBV-80240-02-026**

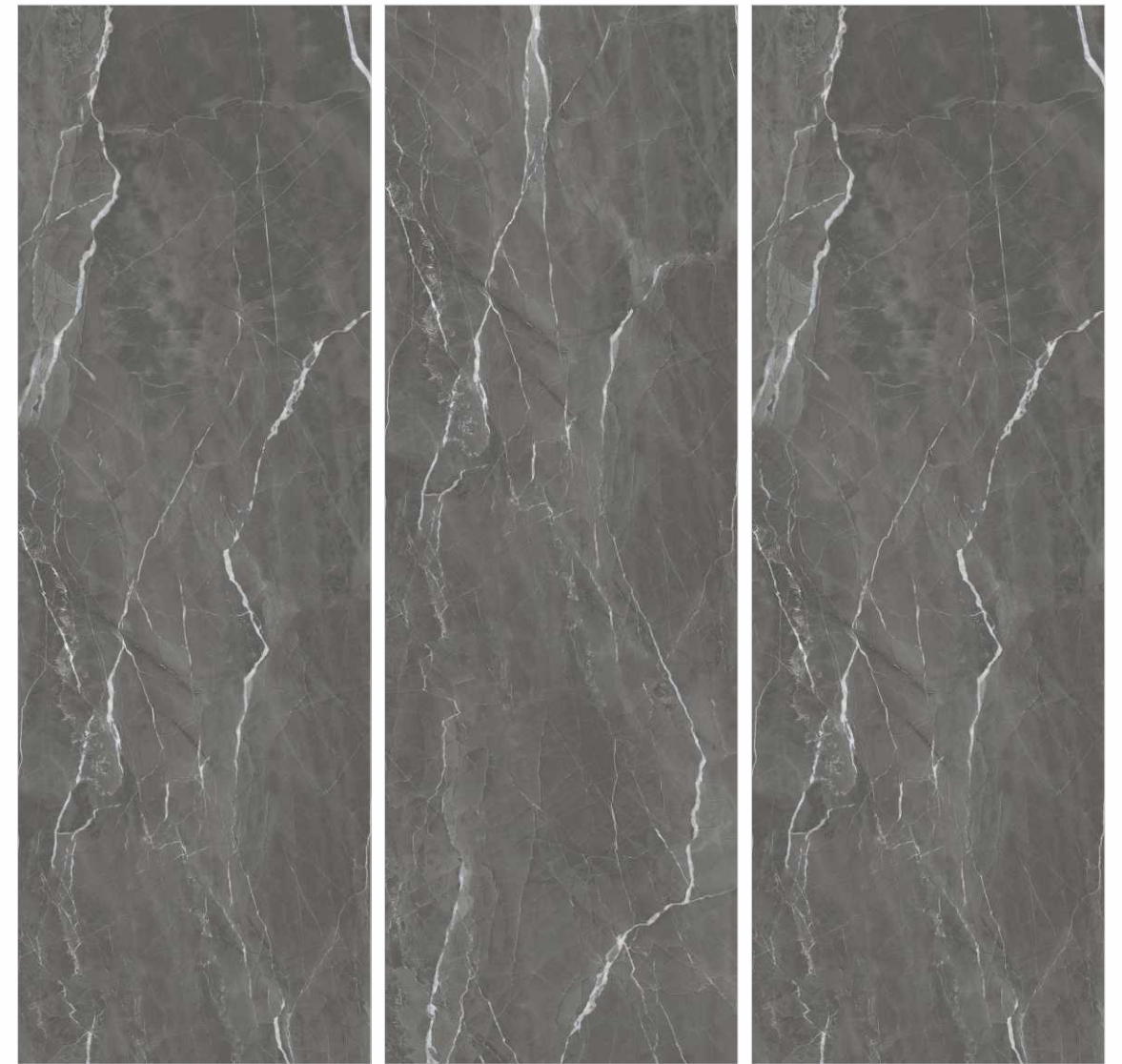

**FBV-80240-02-026**

Size **800x2400mm**  
Surface **High Gloss**  
Thickness **15mm**  
Type **Grey Body**

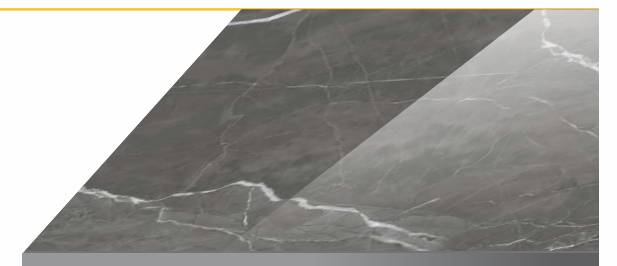





Wall  
**FBV-80240-02-027**

Floor  
**FBV-80240-02-027**  
& **FBV-80240-02-018**



**FBV-80240-02-027**

Size **800x2400mm**  
Surface **High Gloss**  
Thickness **15mm**  
Type **Ivory Body**

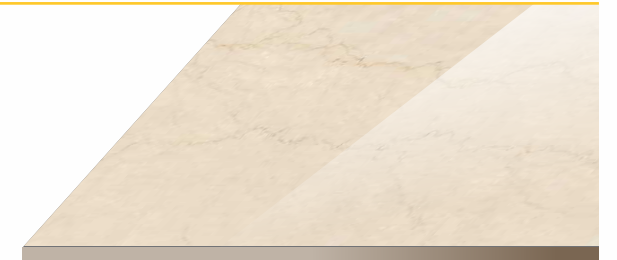





**FBV-80240-02-028**

Size **800x2400mm**  
Surface **High Gloss**  
Thickness **15mm**  
Type **Ivory Body**

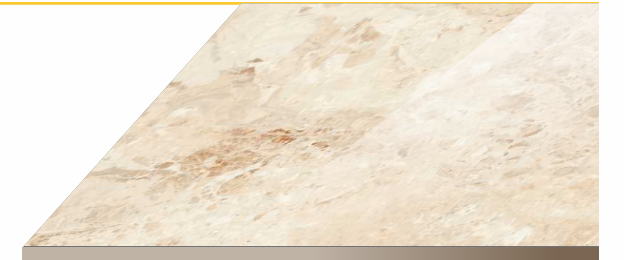





Floor  
**FBV-80240-02-029**



**FBV-80240-02-029**

Size **800x2400mm**  
Surface **High Gloss**  
Thickness **15mm**  
Type **Ivory Body**

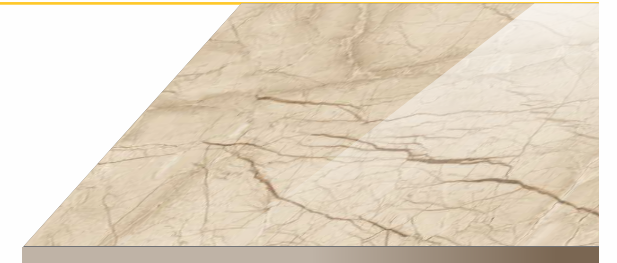



## Slab Handling

### Tools suggested for handling

For handling the enormously sized slabs, we recommend careful handling with the help of four handlers at the same time in case of the largest size and at least two handlers for the smaller sizes of the slabs.

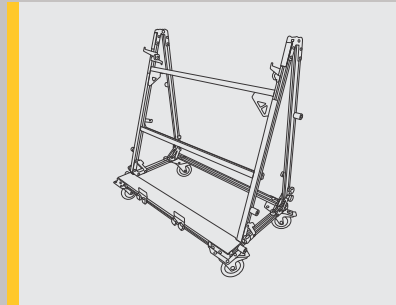

Reinforced trolley



Parallel & transverse guides

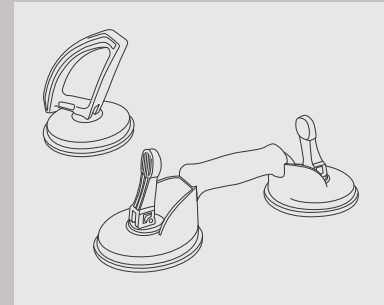

Single & Double suction cup

### Handling instructions

We recommend the use of a kit of devices designed especially for the handling of large-size slabs.

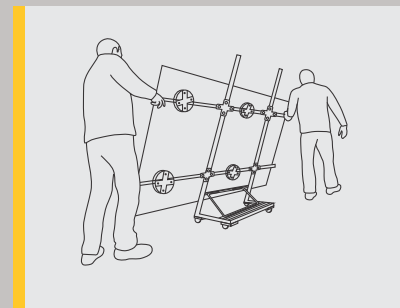

We recommend carrying out the handling job of the slabs with four handlers at the same time.

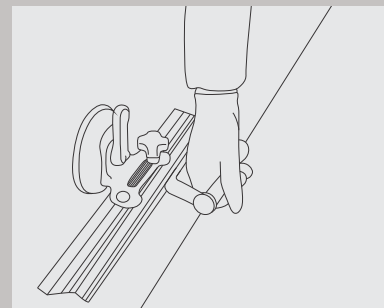

Ensure proper suction with a vacuum between the device and the slab and use a single device/suction cup for a maximum length of up to 150cms.

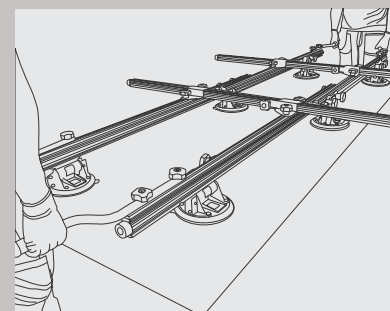

To lift the slabs use sucker cups after cleaning the slab and cups with a damp sponge. Make sure the device also has suckers that run along with the guides and adhere to the slab.

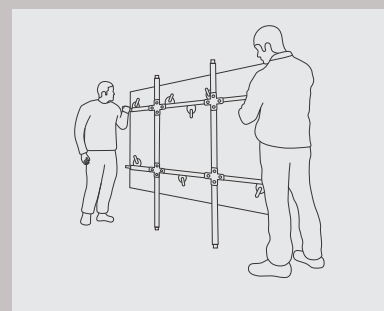

To lift the slab use guides from the long sides of the slab and lift/hang it vertically to the handles of the trolley frame. Use appropriate size reinforced trolley for various sizes of slabs.

## Slab Cutting & Drilling

### Tools suggested for cutting and drilling

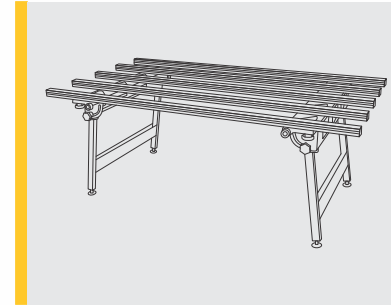

Workbench with aluminum profiles

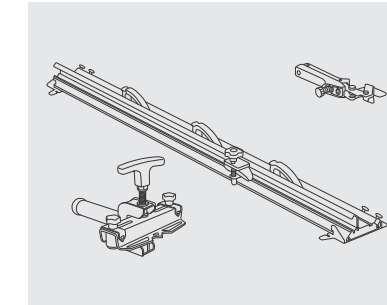

Cutting unit

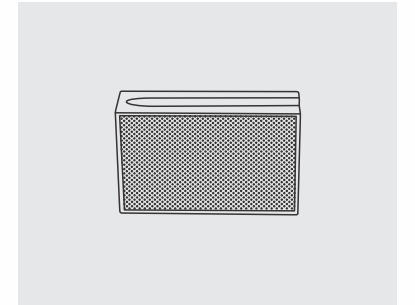

Diamond polishing pads

### Manual cutting instructions

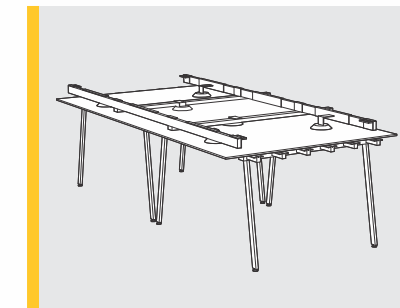

Lay the slab on a flat surface and preferably on a workbench with aluminum profiles. Make sure the surface is stable for both cutting and drilling.

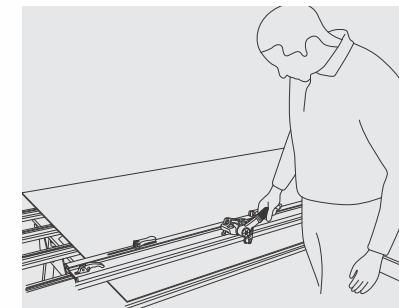

Make markings on the slab according to the desired cutting and drilling need.

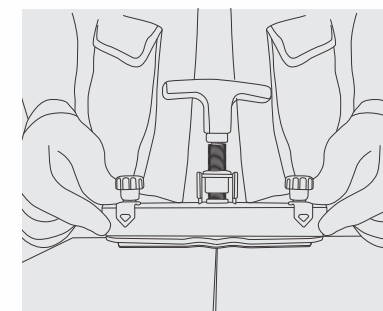

After scoring the length and making the cut, move the slab out of the workbench till the incision line and split from both sides using cutting-off pliers.

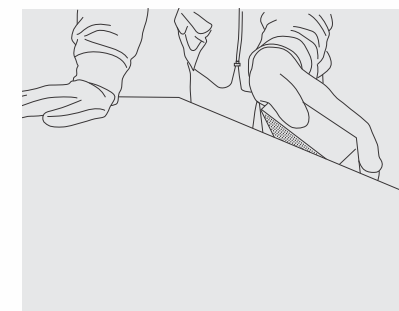

Smooth the edges of the length cut with a diamond polishing pad.



## Slab Laying

Tools suggested for Laying

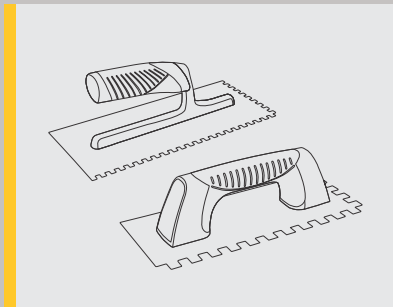

3mm & 10mm trowel

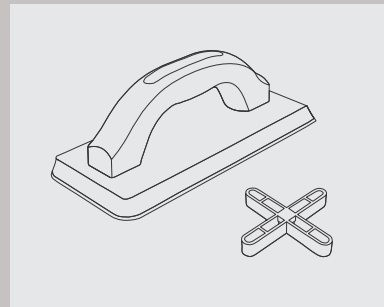

Rubber trowel & Spacers

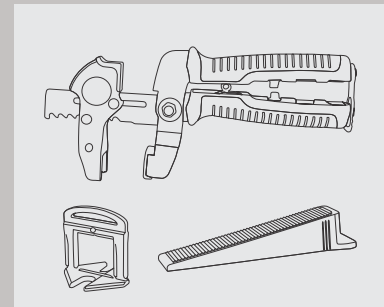

Device for plate's pulling over and Leveling wedges & clips

## Slab Laying Instructions

Check the laying substrate. Make sure it is clean, mature, and homogeneous with no cracks.

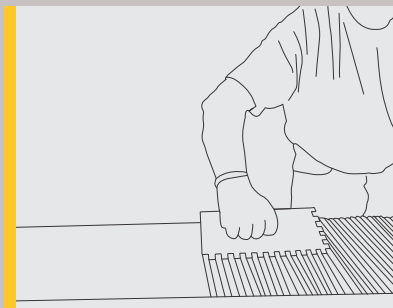

Apply adhesive onto the back of the slab with a 3mm trowel in one direction only.

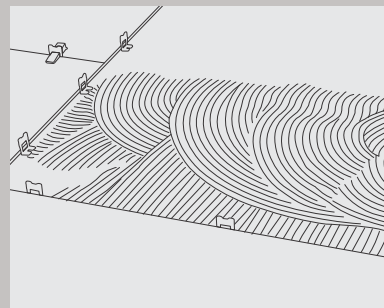

Apply adhesive onto the floor substrate at the same time while applying on the slab with a 15mm U-notch or 19mm V-notch trowel in the same direction as the slabs.

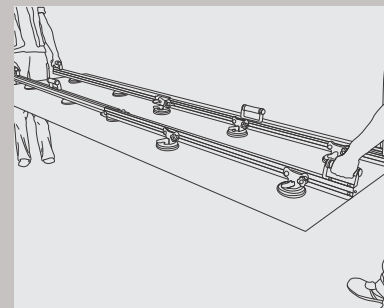

Position the slab on the adhesive bed with a sucker frame with adjustment of a minimum of 3mm joint.

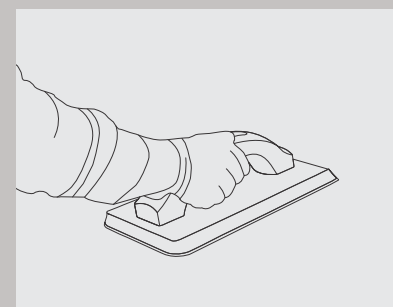

Tap the slab from the center to the edges with a rubber trowel to expel air. Make sure air is expelled and there is no bubble between the slab and the substrate.

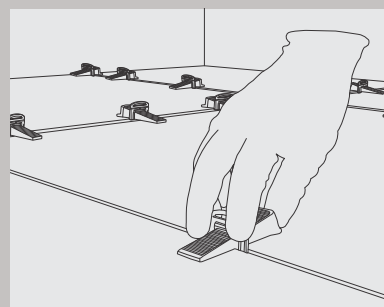

Complete the laying of the slab with a suitable sealant while keeping a 3mm joint through spacers. The special device of pulling over the slabs can be used for easy laying and spacing.

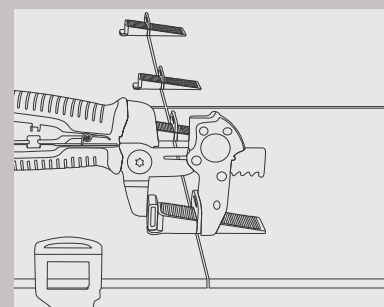

Level the wedges at each linear meter of the slab.

## Slab Edge Possibilities

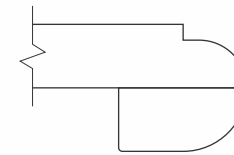

1-1/2" Dupont Bullnose

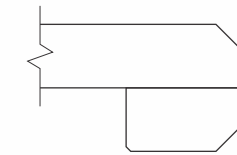

1-1/2" Pencile Edge

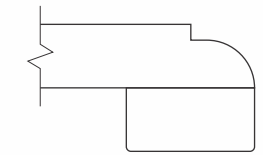

1-1/2" Dupont Square

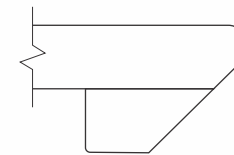

1-1/2" Revers Bevel

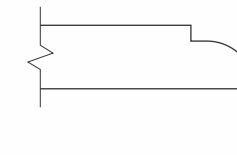

3/4" Dupont Demi

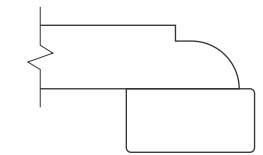

1-1/2" Dupont Step Square

## Cleaning & Maintenance

High-quality raw materials, rigorous production parameters, and world-class technology make the exclusive offering nonporous and thus no dust or deposited waste penetrates the surface.

The no-maintenance surfaces require only a damp cloth for cleaning.

Routine and recurring cleaning spotlights the aesthetic features of the surfaces and keeps the surfaces shining.

For cleaning contamination and stains caused by some common food and other material follow the table below:

TYPE OF STAIN	CHEMICAL PRODUCT	EXAMPLE
Grease	Alkaline - Solvent	Detergent
Oil	Solvent	Ammonia, Baking Soda
Ink	Oxidant - Solvent	Alcohol, Liquid Bleach, Nail Paint Remover
Rust	Acid	Hydrochloric Acid, Vinegar, Red Harpic
Lime	Acid	Descaling Reagent, Hydrochloric Acid
Cement	Acid	Hydrochloric Acid
Wine	Alkaline	Ammonia, Liquid Bleach
Coffee	Alkaline - Solvent	Ammonia, Liquid Bleach
Rubber	Solvent	Alcohol, Thinner
Plaster	Acid	Hydrochloric Acid
Candle Wax	Solvent	Alcohol, Thinner
Iodine	Oxidant	Liquid Bleach
Blood	Oxidant	Liquid Bleach
Ice Cream	Alkaline	Liquid Bleach

**Note:** It is recommended that any kind of stain needs to get clean immediately / as soon as possible.



# Technical Specification

CHARACTERISTIC	STANDARD AS PER ISO13006:2018/ EN14411 Gr.Bla	STANDARD AS PER IS 15622:2017 Gr.Bla	MEAN VALUE OF OUR	METHOD OF TESTING
<b>Regulatory Properties</b>				
Deviation in Length and Width	±0.30 % (±1.00 mm)	±0.10 %	± 0.10 %	ISO 10545-2/IS 13630-1
Deviation in Thickness	±5.0 % (± 0.50 mm)	±5.0 %	± 5.0 %	ISO 10545-2/IS 13630-1
Straightness in Side	±0.30 % (± 0.80 mm)	±0.10 %	± 0.10 %	ISO 10545-2/IS 13630-1
Rectangularity	±0.30 % (±1.50 mm)	±0.10%	± 0.10 %	ISO 10545-2/IS 13630-1
Surface Flatness Central Curvature	±0.40 % ( ± 1.80 mm)	±0.50 %	± 0.20 %	ISO 10545-2/IS 13630-1
Surface Flatness Edge Curvature	±0.40 % ( ± 1.80 mm)	±0.50 %	± 0.20 %	ISO 10545-2/IS 13630-1
Surface Flatness Warpage	±0.40 % (± 1.80 mm)	±0.50 %	± 0.10 %	ISO 10545-2/IS 13630-1
Surface Quality	>95% defects free	>95% defects free	>95% defects free	ISO 10545-2/IS 13630-1
Small Color Difference (For Plain Colour)	ΔE <1.00	N.A.	ΔE <0.80	ISO 10545-16
Glossiness (Polished)	As per Manufacturer	As per Manufacturer	≥ 90	Gloss Meter 60°
Glossiness (Satin)	As per Manufacturer	As per Manufacture	7 ≤ Gloss Value ≤ 25	Gloss Meter 60°
<b>Structural Properties</b>				
Water Absorption	≤0.50 %	≤0.080 %	≤0.080 %	ISO 10545-3/IS 13630-2
Bulk Density	As per Manufacturer	Min 2.20 g/cc	> 2.28 gm/cc	ISO 10545-3/IS 13630-2
<b>Massive Mechanical Properties</b>				
Modulus of Rupture	Min. 35.0 N/mm <sup>2</sup>	Min. 35.0 N/mm <sup>2</sup>	Min. 40.0 N/mm <sup>2</sup>	SO 10545-4/IS 13630-6
Breaking Strength Thickness ≥7.5 mm	Min 1300.0 N	Min 1300.0 N	Min 6000.0 N	ISO 10545-4/IS 13630-6
<b>Surface Mechanical Properties</b>				
MOH'S Hardness #	As per Manufacturer	Min. 5	Polished Min 4**/ Satin & Posh Min 6	BS EN 15771/IS 13630-13
Surface Abrasion Resistance #	As per Manufacturer	Min. Class II	Polished Min II**/ Satin & Posh Min III	ISO 10545-7/IS 13630-11
<b>Thermal Hygrometric Properties</b>				
Moisture Expansion	Max 0.06% (0.6 mm/m)	Max 0.02 mm/m	Max 0.02 mm/m	ISO 10545-10/IS 13630-3
Thermal Expansion(COE) at 100°C	As per Manufacturer	Max. 6.0 x 10 <sup>-6</sup>	Max. 6.0 x 10 <sup>-6</sup>	ISO 10545-8/IS 13630-4
Thermal Shock Resistance	Min 10 Cycle	Min 10 Cycle	Min 10 Cycle	ISO 10545-9/IS 13630-5
Impact Resistance(COR) #	Min. 0.55	Min 0.55	Min 0.55	ISO 10545-5/IS 13630-14
Frost Resistance	As per Manufacturer	As per Manufacturer	Frost Proof	ISO 10545-12/IS 13630-10
Crazing Resistance at 7.5 bar	4 Cycle	4 Cycle	4 Cycle	ISO 10545-11/IS 13630-9
<b>Chemical Properties</b>				
Resistance to Staining Glazed	Min. Class 3	Min Class 1	Min. Class 3/Min. Class 1	ISO 10545-14/IS 13630-8
Resistance to Household Chemicals & Swimming Pool Salts Glazed	Min Class GB	Min Class AA	Min Class GB/Min Class AA	ISO 10545-13/IS 13630-8
Resistance to Low Concentrate Acid and Alkalis Glazed	As per Manufacturer	As per Manufacturer	Min Class GLB***/ Min Class A***	ISO-10545-13/IS 13630-8
Resistance to High Concentrate Acid and Alkalis Glazed	As per Manufacturer	As per Manufacturer	Min Class GHB***/ Min Class A***	ISO-10545-13/IS 13630-8
<b>Safety Properties</b>				
Skid Resistance - (DCOF-WET PENDULUM)##	As per Manufacturer	As per Manufacturer	Glossy ≥P0,Satin,Posh ≥P1	BS 7976-2
Slip Resistance -Satin/Posh (DCOF- R Value )##	As per Manufacturer	As per Manufacturer	R9 to R10	DIN 51130
Lead and Cadmium release	As per Manufacturer	N.A.	Does not yield Pb & Cd	ISO-10545-15

## Packing Detail

SIZE	THICKNESS	PCS/BOX	AREA/BOX	BOX/WT.
800x2400mm	15mm	1 pc	1.92 mt <sup>2</sup>	67 kg

# PRODUCTS

---

FLOOR TILES, WALL TILES,  
ELEVATION TILES, PARKING TILES,  
LABORATORY TILES, ROOF TILES,  
PEBBLE TILES, FULL BODY SLABS,  
QUARTZ SLAB & SPC FLOORING

GRANITES, MARBLES,  
SANDSTONES, ELEVATION STONES

TILES ADHESIVE & CHEMICALS,  
FLOORING ACCESSORIES  
MATERIALS

MODERN SANITARYWARE  
ELEGANT CP BATHROOM,  
KITCHEN FIXTURES & FITTINGS

